

CHOOSE FROM SEVEN DIFFERENT CONFIGURATIONS

SIMULTANEOUSLY EXCISE MULTIPLE BANDS FROM GELS

Actual size GridCutters below – trim out to see what size suits you!
Custom configuration available.

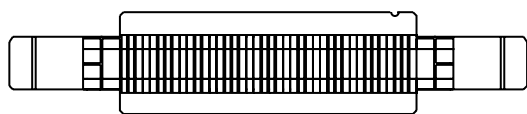

CAT# MEE-1X5, cutter
1.0mm x 5.0mm
CAT# MEF-1.5, mount

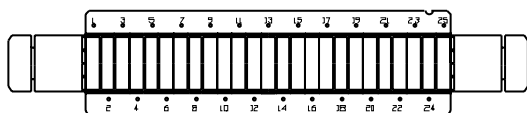

CAT# MEE-2X7, cutter
2.0mm x 7.0mm
CAT# MEF-1.5, mount

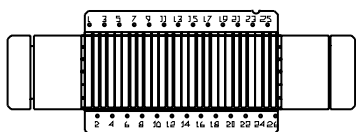

CAT# MEE-1X10, cutter
1.0mm x 10.0mm
CAT# MEF-11, mount

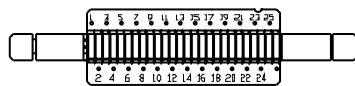

CAT# MEE-1X3.5, cutter
1.0mm x 3.5mm
CAT# MEF-3.5, mount

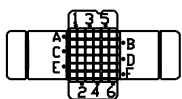

CAT# MEE-1.3X1.3, cutter
1.3mm x 1.3mm
CAT# MEF-8.8, mount

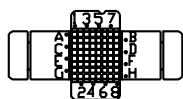

CAT# MEE-1X1, cutter
1.0mm x 1.0mm
CAT# MEF-8.8, mount

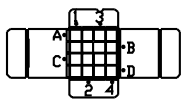

CAT# MEE-2X2, cutter
2.0mm x 2.0mm
CAT# MEF-8.8, mount

OneTouch GridCutter

Multiple band excision

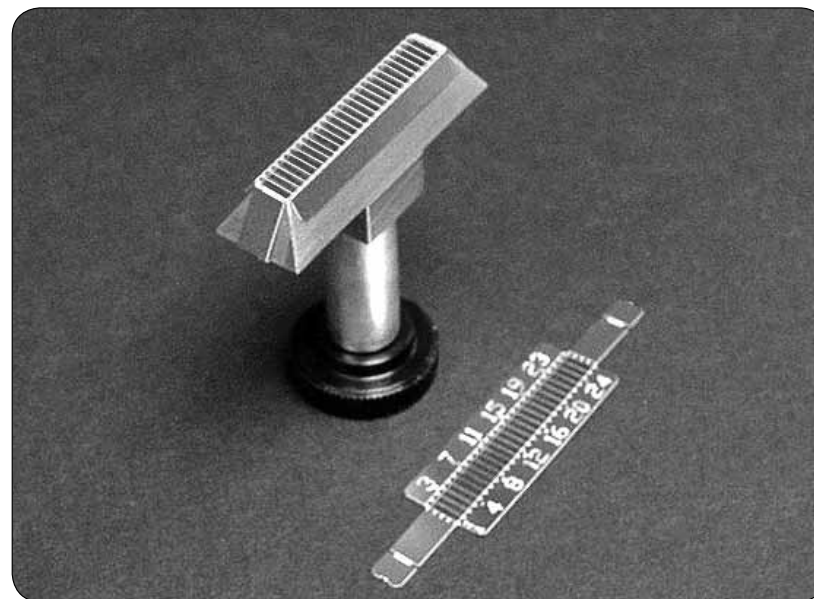

- simultaneously excise multiple gel slices
- disposable blades are numbered for easy identification
- mount and disposable blades are sold separately
- mount comes with special pick for band removal
- available in multiple sizes – see actual size illustrations on back
- ask about custom configurations



SIMULTANEOUSLY EXCISE MULTIPLE BANDS FROM GELS

custom configuration available

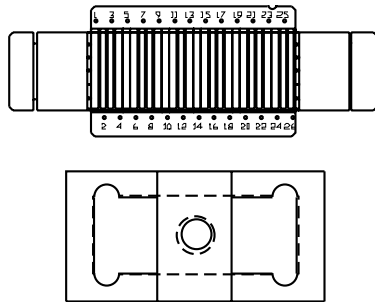

OneTouch GridCutter
CAT# MEE-1X10
Excises 26 bands (1.0mm x 10.0mm)

OneTouch Mount
CAT# MEF-11

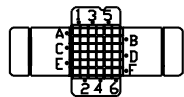

OneTouch GridCutter
CAT# MEE-1.3X1.3
Excises 36 bands (1.3mm x 1.3mm)

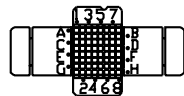

OneTouch GridCutter
CAT# MEE-1X1
Excises 64 bands (1.0mm x 1.0mm)

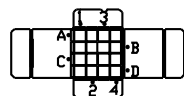

OneTouch GridCutter
CAT# MEE-2X2
Excises 16 bands (2.0mm x 2.0mm)

OneTouch Mount
CAT# MEF-8.8



SIMULTANEOUSLY EXCISE MULTIPLE BANDS FROM GELS

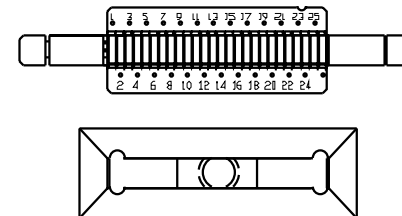

OneTouch GridCutter
CAT# MEE-1X3.5
Excises 26 bands (1.0mm x 3.5mm)

OneTouch Mount
CAT# MEF-3.5

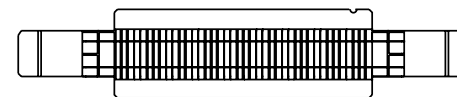

OneTouch GridCutter
CAT# MEE-1X5
Excises 40 bands (1.0mm x 5.0mm)

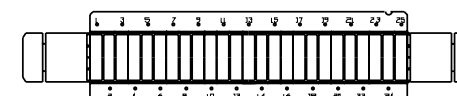

OneTouch GridCutter
CAT# MEE-2X7
Excises 25 bands (2.0mm x 7.0mm)

OneTouch Mount
CAT# MEF-1.5

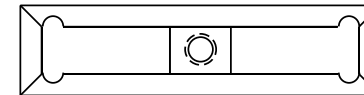

ACCESSORIES

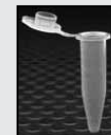

G-Tubes
Low protein binding
microtubes for in-gel
digestion

CAT# LPB65-100\$17
100/pack - 0.65ml

CAT# LPBT65-50\$27
50/pack - 0.65ml
individually wrapped



665 Third Street, Suite 240 | San Francisco, CA 94107
415-247-8760 (tel) | 415-247-8765 (fax)
www.gelcompany.com